



WWW.EUROMOTOELECTRICS.COM

EnDuraLast III Charging System Installation Guide

Upgrade for the BOSCH 3-phase charging system.

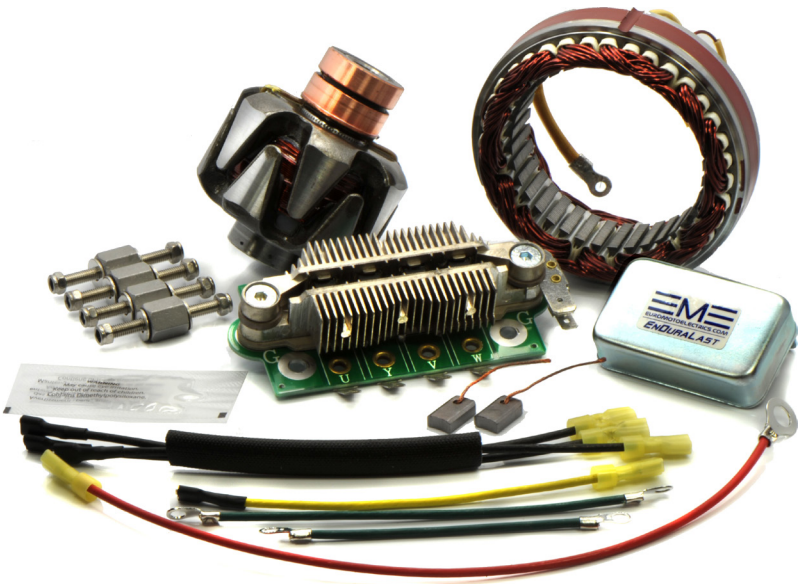

Table of Contents

Product Overview/Warranty	Page 2-6
Installation of Components	Page 7-13
Gen Lamp Modification (<i>optional</i>)	Page 14-15
Setting adjustable Voltage Regulator	Page 16-18

Thank you for your purchase!

This kit, when properly fitted, is extremely reliable and efficient. Please read the installation guidelines carefully. For clearer images, download the .pdf file from our website. To view these installation instructions online visit our website and search for "EDLIII-ALTKIT" in the search box. Then click the product link and click the "Extended Info" tab.

Warranty

This kit is warranted from defects in material and workmanship for 1 year from date of purchase. Euro MotoElectrics disclaims all other warranties, either expressed or implied. This includes any implied warranty of merchantability of fitness for a non-specific use, and neither assumes nor authorizes any other person or professional installer to assume for it any liability in connection with the sale of this product, or for any consequential damages or incidents arising from its use. Any unauthorized modifications or substitutions to the system components will void the warranty.

Notes & Disclaimers:

- The components of this kit are manufactured by a major original equipment charging system parts manufacturer and adapted for fitment to BMW R-Series and Moto Guzzi motorcycles. The components were computer tested prior to being shipped from the ISO certified factory. They are a matched set in terms of electro-mechanical electrical production and electronic voltage regulation, as well as AC / DC rectification. Any unauthorized modifications or substitutions to the system components will void the warranty.
- The installation of this charging system assumes the installing technician has basic mechanical and electrical skills. Please understand the intricacies of working on 10-35 year old vehicles may require additional work to the wiring and fitment of this kit not specifically covered in the following guidelines.
- Due to the variety of motorcycles to which this kit can be fitted, it is not possible to cover all the potential options. The included instructions cover most BMW motorcycles. Special notes for Moto Guzzi bikes or specific BMW years/models are made when available, but are NOT to be considered all-inclusive. When your model is not covered, use these instructions as a guideline for proper mounting/wiring procedures.
- **IMPORTANT: Read through this set of installation instructions completely and make sure you understand all steps to be performed prior to starting any work !**
- Develop an installation plan prior to initiating.

Before beginning work, confirm that you have the correct stator frame diameter:

Bosch Alternator #	Stator Frame Size (Diameter mm)	
0 120 340 001	105	
0 120 340 002	105	
0 120 340 003	105	
0 120 340 004		107
0 120 340 005		107
0 120 340 006	105	
0 120 340 008		107

There may be some cross-over on BMW applications; so please be careful!

BMW 1970-1976 ~ 105mm

BMW 1974-1975 ~ 105mm or 107mm

BMW 1976-1995 ~ 107mm

Moto Guzzi – ALL: 105mm

If label is not there you can measure the stator frame where it inserts into the timing chain cover.

Recommended Good Working Practices:

- Ensure that the motorcycle is clean and dry before beginning any work to ensure that dirt and moisture do not get into internal areas of motorcycle, and to ease identification, removal, and installation of parts.
- Make sure all your tools are in good repair and fit fasteners properly. This prevents damage to fasteners that might prevent their removal or cause injury to yourself or the bike if the tool slips.
- Don't force a stuck fastener!!! Apply a good penetrating lubricant and come back to it later. Heat may also be applied if there is no risk of damaging the component or surrounding items.
- Use a good anti-seize paste on fasteners before reassembling parts to ensure ease of future maintenance.
- Work in a well-lit and comfortable location with a minimum of distractions to allow you to focus on the task.
- When in doubt, ASK ! It is better to be safe than \$\$\$ poorer from required repairs or rework.

Kit Contents:

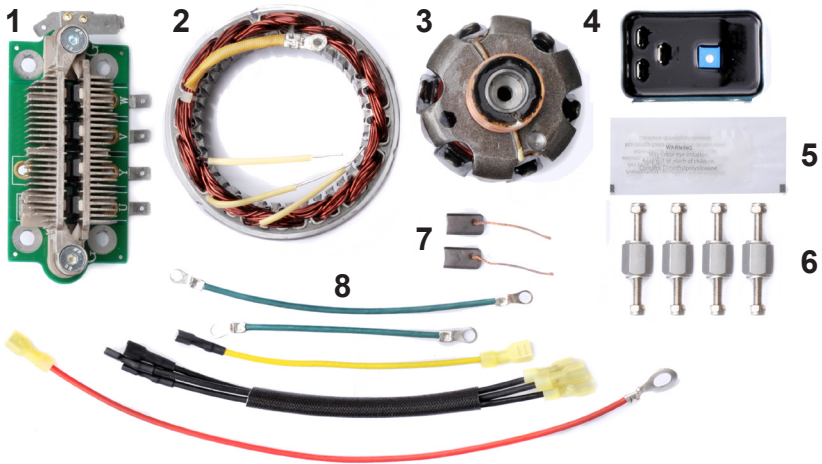

- | | |
|---------------------------|-------------------------------|
| 1. Heavy Duty Diode Board | 5. DiElectric Grease |
| 2. Stator Windings | 6. Solid Diode Mounting Studs |
| 3. Rotor | 7. Brushes |
| 4. Voltage Regulator | 8. Wiring Kit |

Required Tools & Supplies

- Set of metric hex key wrenches (Allen wrenches for machine head screws or aka socket head screws)
- Set of metric open and box end wrenches
- Electrical wire cutter & wire stripper
- DC voltmeter capable of reading up to 15 volts DC
- Torque wrench with 2.5–20 ft-lbs(3.4–27 N-m) range
- Soldering iron

Recommended Tools & Supplies:

- Set of metric hex sockets & ratchet
- Set of flat tip & Phillips screwdrivers
- DC ammeter capable of reading up to 40 amps DC current
- Anti-seize paste for assembly of bolted/screwed connections

After Installation:

Do not overload the system! Although you will have dramatically increased your wattage amperage output, you must still observe the laws of physics and electromagnetism. Please review the wattage demands of all additional accessories prior to installation and / or use. To protect the reliability of the charging system, there should be a 10-20% buffer margin between demand and output capacity at your engine operating speed.

Total wattage demand should NEVER exceed the wattage capacity of the system. The original equipment Bosch charging system needs to have an operating charge warning light because the rotor field excitation current is initiated through the warning lamp circuit. If the charge lamp is burnt out, the rotor does not get any startup current, so no charging occurs.

Mechanical Installation of Components:

The following mechanical installation steps are typical for most BMW models. However, your motorcycle can be different from the vehicle used in the photographs for these instructions. Also, given the age of our motorcycles, previous owners might have performed mechanical or electrical modifications to your motorcycle that might affect the installation of this charging system.

For Moto Guzzi owners, use these instructions as a guideline to the steps to be performed to install the charging system on your motorcycle. Many steps will be identical. However, due to differences between the two makes of motorcycles, some steps might need to be modified to accommodate your specific application.

*Read through both the mechanical **and** electrical installation instructions before you begin any work to ensure that you understand and are capable of completing all the steps. If you are unsure about any part of these instructions, consult a knowledgeable source about your vehicle before proceeding.*

Electrical Installation of Charging System:

Recommended good working practices when installing wiring:

- Do not reuse old wires or connectors when assembling wiring harnesses. The pennies saved will cost you time and frustration down the road with poor connections and hard-to-trace symptoms.
- Size wire gauge properly based on the current load that will be carried by that wire. When in doubt, it is always better to go up to a heavier gauge wire.
- Use cable sheathing over wires in areas subject to motion or abrasion to protect the insulation from being worn through.
- Route wires to avoid pinching and moving parts.
- Ensure that there is enough wire length to prevent tension at connections.
- For crimped connections, be sure to use a quality crimping tool that properly stakes the wires into the connector. Dielectric grease should be used in crimped connections.
- When possible we recommend that you solder all permanent connections.
- Use dielectric silicone grease (included item # 15) for both crimped and removable connections. This prevents corrosion in the connections, assisting in maintaining better long-term conductivity in the wiring. Coat wires with dielectric grease before inserting into connectors to be crimped, and fill female half of all quick-connect plugs and connectors.
- Use heat-shrink tubing on connections to seal against moisture and prevent shorts. Do not use electrical tape because the adhesive eventually fails, unravels and can expose the connection.
- **The use of LI IR and Dry Cell batteries is not recommended or supported for warranty. Due to the higher internal plate resistance damage to the regulator/rectifier may occur. AGM wet acid batteries are recommended and original equipment on your motorcycle.**

Getting Started:

1. To ease working in the front area of the vehicle, we highly recommend that the motorcycle be placed on center stand or safely jacked with front wheel off of the ground before you begin work.

2. Ensure that vehicle ignition is turned to OFF, and disconnect ALL wires from the Negative battery terminal to ensure against shorting of current during installation of components.

CAUTION: *All wires at the negative battery terminal must be disconnected to prevent any grounding path back to the battery before you remove the engine covers to prevent against an accidental short. If a short occurs, electrical components and wiring in the motorcycle can be **destroyed**.*

3. Open or remove the seat, and remove the fuel tank from the motorcycle. Support the fuel tank so it is not resting on the taps when set down, and is clear of your working area. *(If the tank is full, fuel can drip from the vent if the tank is sloshed too much.)*

4. If your motorcycle has any kind of lower fairing panel or protection bars that interfere with removal of engine front cover, remove these and set them aside.

5. If so equipped, remove the oil cooler from mount in front of engine and move it to the side. *(The oil lines do not need to be disconnected, just secure the cooler out of the way to the side)*

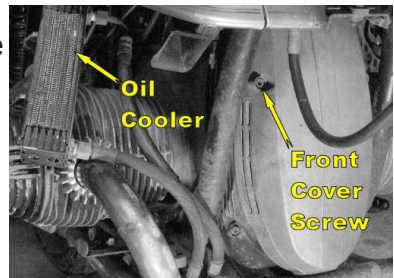

6. Remove the screws securing the front cover (timing cover) and pull the cover straight forward to remove it from the engine.

7. For flat air cleaner models, remove the air cleaner cover and the filter element. For round air cleaner models, remove left carburetor air tube and left air cleaner housing. Remove the filter element, and then remove right side air cleaner housing.

8. Remove the screws securing the top (starter) cover as shown to right, and pull cover up and slide to rear to remove the cover from the engine.



9. Disconnect the plug from voltage regulator and remove regulator from motorcycle.

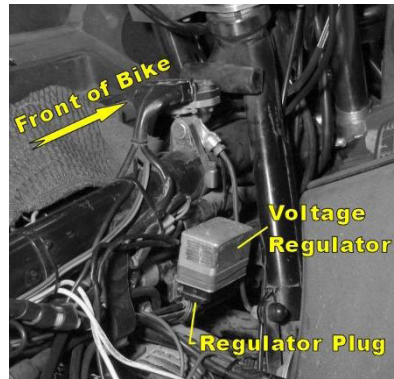

10. Disconnect the wires from the diode board, and remove the diode board from its mounts. (*Be especially careful not to lose the hardware into the timing cover.*)

NOTE: Diode board is behind front cover on BMW cycles; For Moto Guzzi it is under the seat near the left side cover.

11. Remove the rubber diode board mounts and replace them with the four solid metal mounts included with the kit using a 13mm wrench. (The crankcase vent hose may need to be removed temporarily to reach the back of the diode board. Cover opening with duct tape to avoid contamination) Often the temp-

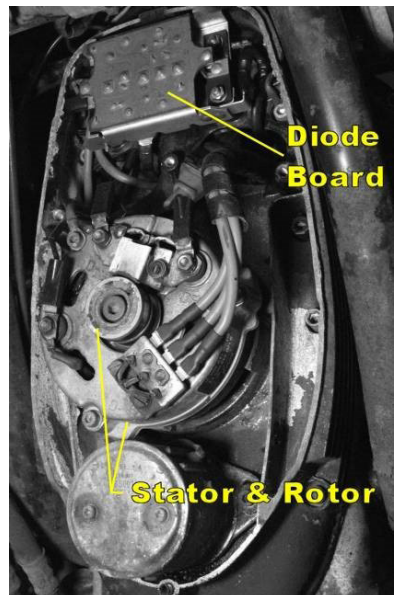

erary removal of the starter is needed to access all of the mounting studs.

12. Carefully remove all the wiring from the stator.
13. Loosen and remove the three screws holding the stator frame to the engine, and pull the stator straight off of the engine. The stator may be tight and need tapping with a rubber mallet to loosen.

Moto Guzzi motorcycle wiring should be treated similarly. You MUST COMPLETELY DISCONNECT the wire from the diode board to the positive terminal of the battery to prevent shorts. Do NOT leave this wire connected to the positive battery terminal.

13. Place the engine in gear to assist in the next steps. You may need an assistant to hold the rear brake while turning the rotor bolt to hold the engine against turning. *(or wedge a block between the depressed brake lever and the foot peg to hold rear wheel if needed)*

14. Loosen and remove the bolt securing the rotor to the end of the crankshaft using a 6mm allen wrench

15. Loosen and remove the bolt securing the rotor to the end of the crankshaft.

16. Remove the rotor with a rotor removal tool. Tapping the rotor with a rubber mallet after tightening the rotor removal



Available from Euro MotoElectrics
EME Part# BOALT-Rotor642Tool

tool can assist in releasing the rotor from the crankshaft. Keep repeating to increase tension on the removal tool and tapping with rubber mallet from different sides and angles for stubborn rotors.

- The rotor can “pop” off the end of the crankshaft. Be prepared to catch it as you tighten the bolt, or have soft padded material under the front of the motor to catch the rotor if it falls.

17. Reinstall rotor bolt and tighten the bolt against the removal drift to unseat the rotor from the crankshaft taper. *Do not tighten bolt to more than 14 ft-lbs (19N-m) of torque or bolt may break off in crankshaft.*

18. Thoroughly clean off the three seating surfaces of the stator frame, and inspect the oil seal where the rotor installs into the timing cover. If the seal is hard, cracked, or even suspect, replace it now with a new one.



19. Thoroughly clean the tapered surface of the crankshaft with an evaporating solvent to remove ALL traces of dirt, oil, fingerprints, etc. You want bare, dry metal.

20. Carefully remove the plastic protective cap from end of rotor. *IMPORTANT: Be very careful not to damage the polished seal contact surface below cap. We recommend you use compressed air blown through bolt hole to remove the cap.*



Replacements can be purchased from EME:

BMW # 11 14 1 255 011
EME Part # BMWSeal-011

Moto Guzzi # 904 028 40
EME Part # MGSeal-840

Available from
www.euromotoelectrics.com

21. Thoroughly clean the inner tapered surface of the rotor with an evaporating solvent to remove ALL traces of dirt, oil, fingerprints, etc. You want bare, dry metal on this surface.

22. Apply a thin film of clean engine oil to the rubber lip of the oil seal and the polished seal-contact surface of the rotor.
IMPORTANT: DO NOT apply any oil to the tapered inner surface of the rotor bore or to the crankshaft. This is a DRY friction fit.

23. Carefully insert rotor onto crankshaft and into seal. Keep the rotor straight and centered as you insert it to prevent damage to the oil seal.

24. Tighten the rotor on the crankshaft using the new bolt and lock washer {items #6 & 7}. Torque the bolt to 14 ft-lbs (19 N-m). **Do not over-tighten.**

25. Remove the brush holder by loosening the “DF” and “D-“ post hardware.

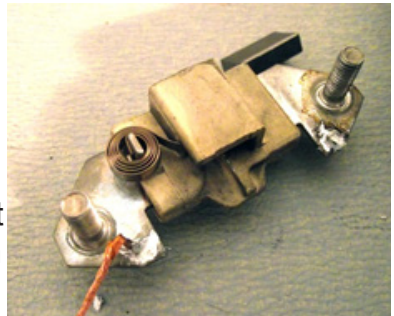

26. Using a soldering gun heat the solder that attaches the brush to the frame of the brush holder. Once the solder becomes malleable pull the brush from the solder hole on the brush holder for both the “D-“ and “DF” terminals.

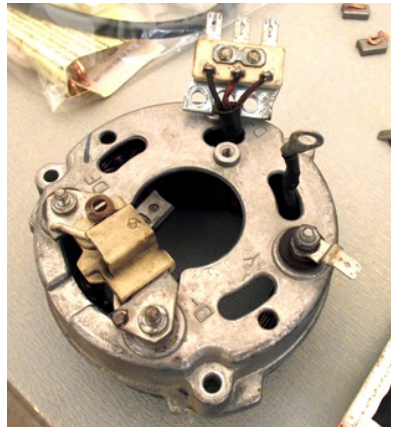

27. Clean the excess solder from the brush holder solder holes in preparation of attaching the new carbon brushes. (A small drill bit is very useful at this step to open the solder holes to insert the carbon brush wire.)

28. Now solder each brush into the brush holder ensuring a clean soldered connection and insert the brushes into their spring locked compartments. (An assistant is helpful during the soldering stage to ensure clean workmanship.)

29. Attach the brush holder to the stator frame while paying close attention to the placement of the bushing, insulated washers and blade terminals. 30. Un-soldering the WVU wires from the stator frame. If applicable, unboolt the Y lead from the stator frame. Remove the old stator from the stator frame.

31. Mate the new stator into the stator frame while routing the WVU and Y leads through the stator cover just as the old stator was connected.

32. Solder the WVU wires to the holder. Sequence of the WVU makes no difference at this point so any of the three leads can be designated W, V, or U.

33. Attach the Y lead to the existing or newly placed Y lead holder if applicable.

34. Carefully reattach the new stator and stator frame onto the three timing cover seating surfaces using the three stator frame bolts previously removed. (It may be necessary to gently tap the stator housing with a mallet to seat it before tightening the stator bolts.)

35. Ensure that the alternator brushes line up with the commutator slip rings.

36. Connect the new wiring harness to the diode board and attach the new heavy duty diode board onto the solid metal mounts with the W / V / U and “Y” terminals facing down.

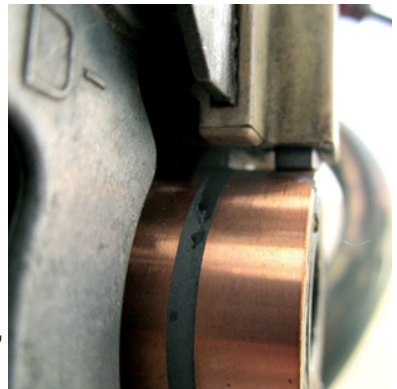

37. Bolt the new metal adjustable voltage regulator onto the tab that the old mechanical voltage regulator was removed from.

38. Reconnect all wiring according to the stock configuration. Use the simplified wiring diagram below for assistance.

Dont forget the D+ terminal on the back of the diode board

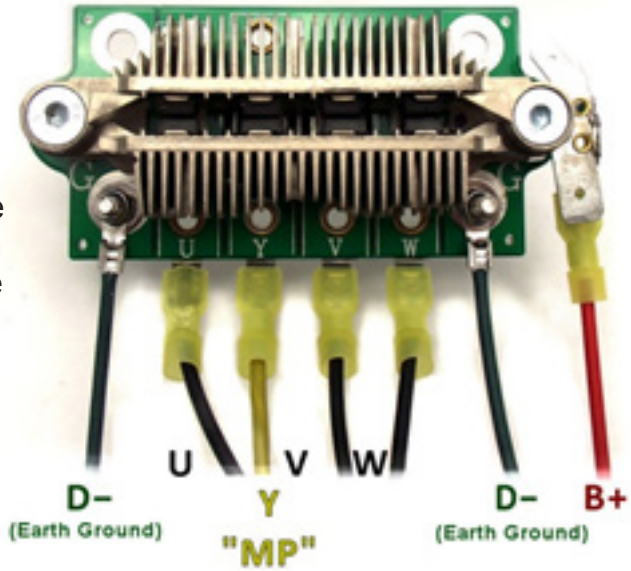

When finished the Installation should look as shown here:

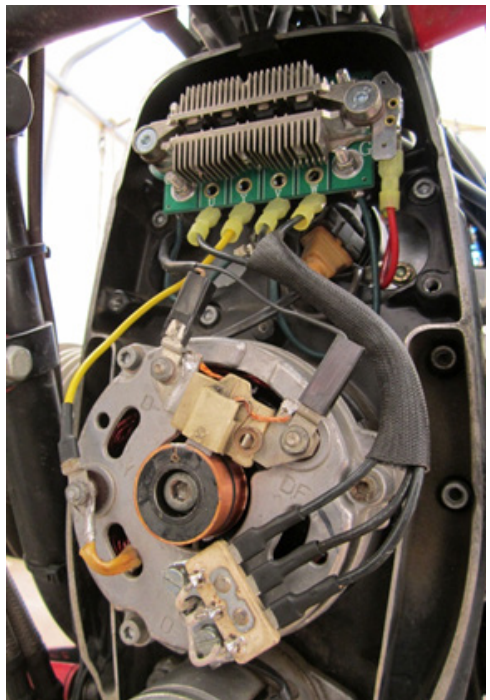

GEN Lamp Energizing Circuit Modification

Optional - NOT included in the kit.

The energizing circuit on Bosch alternators passes through the GEN lamp. If the GEN lamp bulb happens to burn out it will interrupt the charging circuit and will not allow your alternator to charge your battery. To bypass the GEN lamp you will need a resistor wire with a resistance value of 330 Ohms or higher. Any resistor can be used in this modification; the important trait is the resistance value.

NOTE: If you choose to install this modification on your motorcycle be aware that if the bulb is burned out the charging system will not begin charging at as low of an RPM as when the GEN lamp bulb is functional. This modification is a work-around in the EXTREMELY unlikely case that your GEN lamp bulb burns out during a trip.

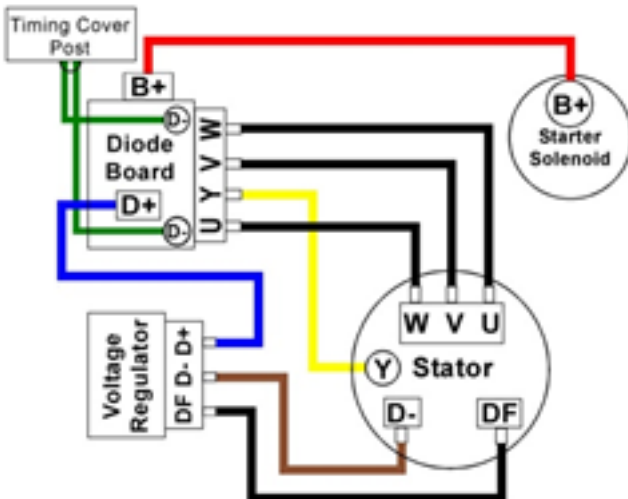

1. Attach the resistor wire to one of the blue (D+) wires that are attached to the voltage regulator. This must be done very carefully to avoid the chance of damage from vibration and exposed wire connections. A Posi-Lock tap connector is recommended to ensure proper workmanship.



2. The other end of the resistor wire attaches to the terminal on the ignition coil that attaches to the battery circuit (Switched Power) with a green/blue wire. The Bosch super 6v coils usually have a spare blade terminal at this post.

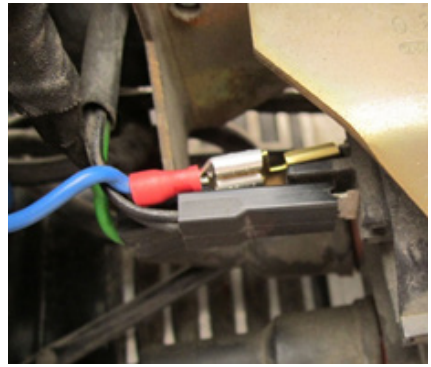

Adjustable Electronic Voltage Regulator

Installation, Adjustment and Recommendations

Digital Voltmeter Required

External Solid State Transistorized Voltage Regulator
with Adjustable Voltage

Euro MotoElectrics Part # **VR-ExtAdj**

Background: The function of a voltage regulator in a charging system is to limit the voltage produced by the alternator to a set limit. In other words, it regulates or limits the voltage to a predetermined set point coming from the alternator to the battery. The voltage regulator has no ability to increase the amperage output of the alternator. It simply regulates voltage below a range that is safe for the battery and other electrical components in the vehicle's electrical system.

The Bosch alternator and charging system used in the BMW and Moto Guzzi has the voltage regulator monitor the voltage across the battery indirectly through diodes in the rectifier / diode board. Therefore a direct method of reading the charging system voltage is to attach the positive lead of the voltmeter to the B+ lead (large male spade terminal) of the rectifier. Due to indirect voltage through the other charging system components, the adjustable voltage regulator allows to compensate for these variations (reductions) and to maximize the voltage sent to the battery.

Feature: This voltage regulator has the feature of allowing the properly informed technician to select the maximum voltage to maximize your BMW or Moto Guzzi charging system.

NOTE: It will not compensate for damaged batteries due to sulfation etc. or other electrical system deficiencies, such as poor or intermittent grounding. It will not increase amperage output.

“Tuning up” the electrical system

- **Battery**

The battery must be in good condition for the voltage to pass through the battery. A 12 volt battery usually requires a minimum of 13.8 to 14.4 volts to achieve a complete charge. This range depends on climatic conditions (temperature) and also the design and overall sulfation state of your battery. An old sulfated battery

with shorted cells will not re-charge to ~14.0 Volts ! Therefore the battery is the basic foundation to begin “tuning-up” the charging system to it’s optimum performance.

- **Inspecting Wiring**

The entire electrical system should be inspected for solid, clean connections, especially the battery cables and all grounds. Clean and tight contacts should be the standard, and it is especially important to focus on all the ground returns. All connections tend to deteriorate over the years due to corrosion, oxidation, etc. on older motorcycles. When in doubt, remove the connection, clean with emery cloth and re-tighten, replacing loose eyelets, grommets, frayed wires, etc.

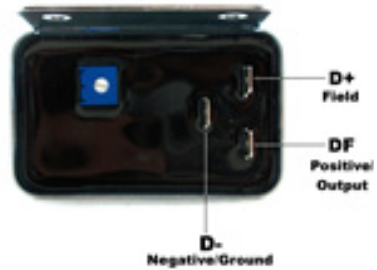

- **Optimizing the “Tune-up”**

If most of your riding is done in urban Stop-&-Go, you may need to set your voltage as high as 14.4 volts. In no case set the voltage over 14.4 volts ! Doing so will boil off water from the battery, eventually damaging the battery, and will probably damage other electrical components as well. For operation where longer duration, higher RPM engine speeds are being used, you may be able to maintain battery charge voltage with as low as 14.1 volts.

Installation and Adjustment of the Adjustable Voltage Regulator

TURN THE SCREW ON REGULATOR
CLOCKWISE TO INCREASE VOLTAGE AND
COUNTER CLOCKWISE TO DECREASE VOLTAGE.

The battery must be fully charged to ensure voltage saturation. Charging may be accomplished by utilizing a battery charger or running the engine during a ride. (Idling the engine will not produce enough volts / amps to charge the battery; higher RPM’s such as during a ride, would be required.) Check with digital volt-meter across the + and – battery posts; should read 12.5 volts.

Turn off the engine. Gain access to the voltage regulator. Gas tank removal may be required. Remove the old regulator and unplug connector. Plug connector into new regulator. Bolting the new voltage regulator back into place is not necessary at this time as access to the voltage setting screw is required. The voltage regulator is grounded through the connector plug (-)

Start the engine with the headlamp turned off (or bulb removed). Increase engine speed to ~ 2500 RPM. The voltage should increase and stabilize. When the voltage has stabilized, use a small screwdriver to adjust the voltage. Turn the small adjustment screw on the back of the voltage regulator clockwise to increase voltage, and counter clockwise to decrease the voltage until the desired voltage is obtained. The voltage should re-stabilize.

If voltage does continue to slowly increase, it probably means the battery was not fully charged and or could be fully charged due to it's condition, and / or due to the charging system's previous condition. Eventually the voltage must stabilize. This needs to be monitored until the voltage is not increasing, especially past 14.4 volts. There should be enough gasoline in the carburetor bowls to complete the above voltage stabilization adjustment. However, if required, re-install gas tank / gas lines, and perform / repeat with fuel supply in place. Upon satisfactory voltage stabilization, re-install the voltage regulator with original bolts, replace fuel tank, etc. Start the engine and re-verify voltage stability. Check voltage reading often soon after installation, especially after long rides. Also check battery fluid level. Ensure your maximum voltage has stability.

Verify workmanship

Review the above and inspect work. Twice. Maybe three times.

- Ensure that all wiring is connected to the proper locations!
Check the wire colors.
- Check that all connections are clean and snug.
- Check wire routing to ensure that wires are not pinched, have no sharp bends, and are not in danger of chafing.
- Ensure that any remaining unused electrical wiring and connectors from the original charging system are properly secured out of the way and insulated against shorting.
- Use tie wraps to hold any loose wires in place and to prevent rubbing from vibrations.

IMPORTANT: The vehicle must have a good, fully charged battery for the electrical system to operate properly !

- Make sure the positive and negative cables are free of corrosion, and have clean tight fit.
- Using a digital voltmeter, the voltage reading **MUST** be 12.43 Volts or higher.
- If your battery is over 3 years old, it should be replaced.
- If your battery has been discharged 3 times or more, it is sulfated and **MUST** be replaced !

A sulfate damaged battery will;

1. **NOT** accept a charge and may damage your charging system.
2. **NOT** provide sufficient voltage and / or current to turn the starter motor.

Battery Voltage	State of Charge / Battery Condition	Recommended Action
12.7 V	100 %	Battery Good
12.6 V	90%	Battery Good
12.4 V	75 %	Charge Battery
12.2 V	50 %	Replace Battery
12.0 V	25 %	Replace Battery
11.9 V or less	Discharged	Replace Battery

Due to older battery high internal battery resistance the charging system has to work harder. While good batteries absorb voltage spikes, older and/or defective batteries may produce voltage spikes that can cause damage to the voltage regulator and / or rectifier, etc. This would create a high voltage and / or low voltage output and may cause the charging system to ultimately fail.

The use of LI IR and Dry Cell batteries are not supported for warranty. Due to the higher internal plate resistance damage to the regulator/rectifier may occur.

EME Euro MotoElectrics
2505 W 2nd Ave #15
Denver, CO 80219
www.euromotoelectronics.com